

Energy Saving of Adaptive Thermal Control for PWM Driven Air-Conditioners

Marcella C.C. Melo, Heyder A.S. Araújo, and Adolfo Bauchspiess

*LARA-Laboratório de Automação e Robótica,
UnB-Universidade de Brasília, 70970-900 Brasília/DF BRAZIL
(e-mail: {cortat.marcella, heyder48}@gmail.com, adolfobs@unb.br)*

Abstract: There is a growing concern about excessive electricity consumption and buildings take an important share on electricity demand. To face the variable thermal dynamics of buildings we propose a self-tuning adaptive controller that provides energy saving while maintaining similar thermal comfort as the conventional On-Off or PI controllers. The study was supported by experiments conducted on a $15m^2$ meeting room. The surrounding temperature, humidity, radiant energy, air velocity, among others, were considered disturbances in a first-principles based reference model. The split air conditioning was operated with a modified PWM (Pulse-Width Modulation) signal in order to obtain smooth behavior, respecting the recovery time of the compressor. The automation was implemented with XBee (IEEE 802.15.4) wireless modules. The recursive identification and the self-tuning of the polynomial pole assignment controller (RST) were implemented in MatLab. Considering variable thermal load (typically occupancy variations and outdoor climatic changes), the energy used by the adaptive RST controller was 45.2% lower than the conventional On-Off controller.

Keywords: building automation, energy efficiency, adaptive control, identification, HVAC.

1. INTRODUCTION

Building automation is one aspect of modernity where technology use has strongly increased in recent years. Research also has been very fruitful. See, for example, Shaikh et al. (2014), for an extensive review on building energy and comfort management. The building can be seen as an intelligent ambient, where different services are provided, almost invisible for the users, considering control and communication aspects. The aim is to provide services such as intrusion avoidance, fire contention, biometric access, door and window automation, smart elevators, HVAC (Heating, Ventilation, and Air Conditioning) automation, and energy saving, among others. Thermal comfort affects the productivity of the occupants and energy saving is considered very important in any Building Management Systems, Nguyen and Aiello (2013). As buildings represent a large parcel of the current electricity demand, Melo et al. (2014), they have also great economic relevance.

In this paper we show advantages of using adaptive self-tuning controllers compared to conventional On-Off or PI control. A modified PWM actuation scheme was used for the split air-conditioner to allow continuous change of the manipulated variable while taking care of the recovery time of the compressor. The methodology was applied to a meeting room at LARA (Laboratory of Automation and Robotics), University of Brasília, Brazil. The model used to design PI and a self-tuning adaptive controller is structured by a first-principles reasoning allowing physical insight on the buildings thermal issues.

Adaptive control of thermal processes in buildings can be tracked back as far as the early 80's. In Nesler (Aug

1986) a first-order adaptive algorithm with RLS (Recursive Least Squares) estimation of the parameters was shown for a multizone air-handling unit. Many adaptation schemes use a model of the process. Very different models like, e.g., artificial neural networks, fuzzy logic, and many different nonlinear schemes were adopted. Adolph et al. (2014) investigate adaptive control strategies for single room heating. PMV (Predictive Mean Vote) and PPD (Predicted Percentage of Dissatisfied), see Fanger (1973), are used in closed loop. The recent review presented by Shaikh et al. (2014) shows that the tendency of the academy for HVAC automation is today more in direction Model Based Predictive Control. The algorithms involved in MBPC are sophisticated and the realization demands a very good process model (which is not easy to obtain).

This paper is organized as follows: Section 2 details the test environment as well as the PWM modification used for split air conditioners. This section also presents the first-principles model used to structure the reference model of the adaptive controller. The adaptive pole-placement self-tuning controller is described in section 3. Section 4 presents the main obtained results, comparing On-Off, PI, and adaptive with respect to control quality and energy saving. Main conclusions are summarized in Section 5.

2. TEST ENVIRONMENT: THE MEETING ROOM

The meeting room used to test the proposed controllers can be seen in Fig. 1. The floor plan of LARA can be seen in Fig. 2. Dashed, the meeting room. The neighboring rooms share strong thermal coupling with the meeting room (mostly glass partitions). The particular building orientation leads to strong direct solar incidence in the



Fig. 1. LARA's meeting room with hybrid split air conditioner.

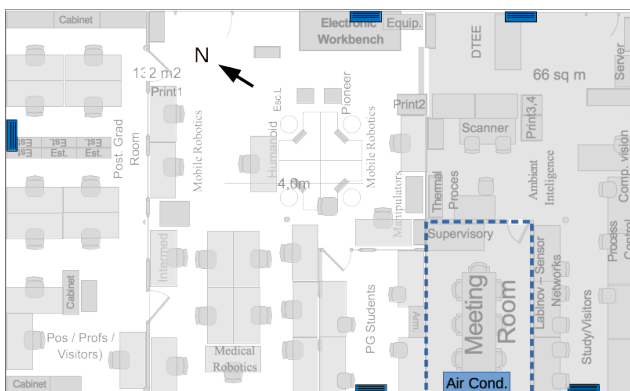

Fig. 2. Floor plan of LARA. Meeting room area is $15m^2$.

afternoon. The meeting room is equipped with a hybrid air conditioner. Evaporative operating mode and standard compressor based mode can be alternated in order to save energy. Different experiments have been conducted to dynamically identify the room and to save energy with different approaches, see e.g., Bauchspieß et al. (2013). We can, for example, compensate some measurable disturbances (e.g., solar radiation, outside temperature), provided adequate instrumentation, but many disturbances still remain and must be attenuated by the closed loop. In the present work, therefore, we consider only the temperature as the main comfort factor, thus, simplifying the design and evaluation of the adaptive controller.

2.1 PWM Actuated Split Air Conditioners

In regions of moderate climate, like the central-western Brazil, it is most likely that only cooling is sufficient to provide thermal comfort. The most efficient air conditioner for non-residential applications is the chiller based central air conditioner. Window air conditioners and split air conditioners, see Fig. 3, (with the noisy compressor mounted outside) are most common for buildings where HVAC was not originally planned. In general it is a retrofitting solution because the destination of the building was not defined from the start. About 50% of Brasilia's climatized public buildings use central air conditioning whereas the others use window, split, evaporative or mixed schemes.

The On-Off controller is a simple and reduced cost solution when the cooling equipment is acquired. But it is not a good solution when we consider the energy waste. Shaikh et al. (2014) point out that the wastage is usually huge due to the substantial instabilities and frequent overshoot of the set points. "These control systems have been employed in various applications and disturbed environmental conditions, and have been poorly performing and generally have not been offered optimal control strategy." The On-Off controller often overcools the room. The switching strategy has some serious drawbacks:

- The dynamics of the system is not taken into account;
- The mean value of the controlled variable is not, in general, the set point;
- No adaptation of the switching, regarding room occupancy or the external conditions, takes place.

PWM has been used for a long time in control applications as a simple and cheap substitute for D/A converters. The high frequent switching of the power delivers the low-pass process with the mean value of the PWM signal. We mention here some previous work from the literature on PWM modifications for air conditioners. Salsbury (2002) used adaptive modulation for HVAC systems. A 1st order model was used. Gwerder et al. (2009) used PWM for thermally activated building systems (TABS), which means that the structure of the building is considered as energy storage. The switching is between heating and cooling. More recently Tianyi et al. (2011) used a fuzzy approach to control the ratio of fan-coil units. The authors claim that 30% energy could be saved.

PWM actuation: The compressor is the most energy consuming part in an air conditioner and is typically controlled by an On-Off thermostat with hysteresis, see Fig.3. The compressor should avoid to be started while the gas pressure is high. After switching off, the switch on procedure has to wait, typically, 4 minutes, in order to preserve the compressor life-cycle (the refrigerant gas pressure has to come down - this reduces the peak starting current of the compressor). In this work a modified PWM scheme will be used, which takes into account the typical recovery time of the compressor. Fig. 4 shows the response of our PWM (out) for a ramp input signal (in). The output state is changed each 250secs. considering the mean value over the past 250s. Considering the thermal time constant of the meeting room is around 240s, we still have the desired low pass effect. The temperature will show some ripple (not to avoid with this kind of air-conditioner), but without noticeable comfort impairment, see for example Figs. 10, 11, and 12 . Thus, we can feed the controller with continuous signals and also preserve the compressor. As can be seen in Fig. 4, higher duty cycles reduce the time between turning the compressor off and then on again (critic for the compressor). That occurs, however, less frequently if the air conditioner is well sized. The normal situation is a small error leading to a small duty cycle and, therefore, large recovery time for the compressor.

2.2 Sensor and Actuator Wireless Network

The instrumentation used in the temperature controllers will be described in this subsection. The Wireless Sensor-Actuator Network (WSAN) uses Arduinos and XBee

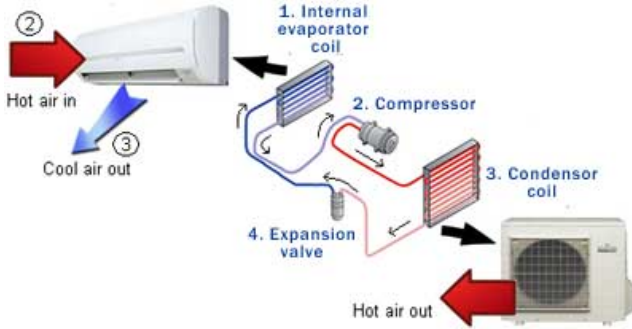

Fig. 3. Split air conditioner. (adapted airintelligence.co)

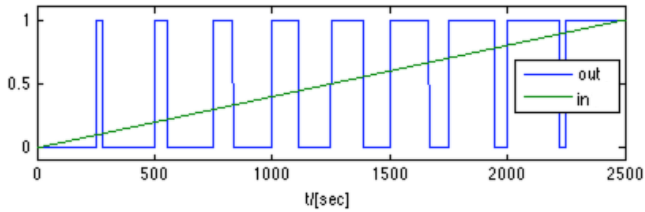

Fig. 4. Modified PWM for air conditioners, $T_{cicle} = 250sec$.

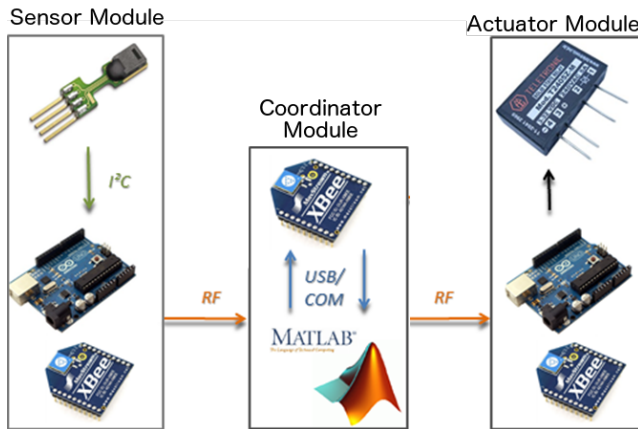

Fig. 5. Wireless Sensor-Actuator Network.

transceivers (from Digi, a member of the ZigBee Alliance). XBee complies to IEEE 802.15.4 and has vendor specific features. Following modules were build, Fig. 5:

- Sensor: Arduino connects an XBee and sensor SHT71;
- Coordinator: an XBee connected to a PC (MatLab);
- Actuator: Arduino connects XBee and a solid state relay, Teletronic T2405Z-M.

The temperature and humidity sensor SHT71 (Sensirion®) uses digital communication, reducing noise significantly. Here only temperature was used. The A/D resolution was set to 14 bits. The connection to a host Arduino module was made over a serial interface. The sensor module is battery driven, the coordinator module is driven by a USB-CON interface (from rogercom.com), while the actuator module uses the 220 V power supply at the air conditioner.

2.3 Dynamic model of the meeting room

To design a self-tuning controller, a reference model of the process is necessary. As buildings are MIMO distributed time-varying processes with some nonlinear components,

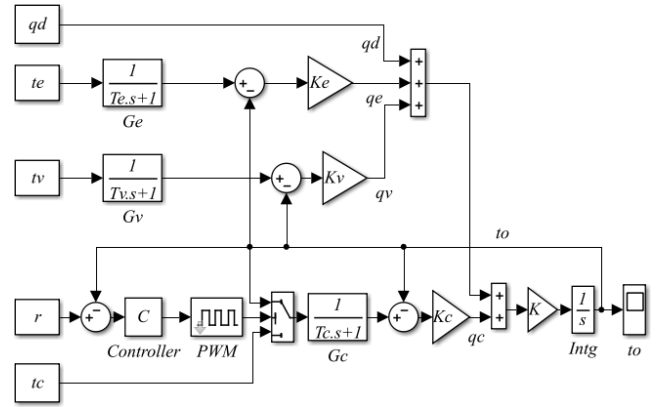

Fig. 6. First-Principles based model of the meeting room. Temperatures: r - reference, y - controlled, t_e - external, t_v - vicinity, t_c - cooler. Time constants: T_e , T_v , T_c . Gains: K_e , K_v , K_c , K . Heat flows: q_e , q_c , q_v , q_d .

it is not so easy to choose a suitable model. A grey-box identification, and in particular a first-principles model, has as main advantage over black-box models (input-output identification) that the physical parameters of the system can be associated to constructive parameters of the building. This could be useful for retrofitting. For example, the heat flow obtained by the model can show that some wall is a heat leak. A thermal process is by nature a distributed system. For practical reasons we will consider only a few measurement points. Normally one temperature sensor per thermal zone. Also a reduced number of actuators are normally available for thermal comfort in buildings.

The meeting room, see Figs. 1 and 2, is $3 \times 5 m^2$ with a height of approx. 3.5 m. The external wall is mostly of glass. One internal partition has good isolation. The two other internal partitions are composed, partially, of glass. Due to good isolation, thermal flow through the floor and ceiling will not be considered. The meeting room reference model, thus, uses four heat flows to explain the output temperature t_o : q_c - from the air conditioner, q_v - from the vicinity (neighboring rooms), q_e - from outside, and q_d - resulting heat flow from all other disturbances not modeled by the previous terms (e.g., solar radiation, mean thermal radiation, humidity, change of occupancy, etc.).

We will consider a simplified first-principles structured model of the meeting room, (adapted from Bauchspiess et al. (2006)), Fig. 6. The temperature of the meeting room is modeled as a function of external temperature and neighboring rooms. The air conditioner is modeled as a switch and a first order dynamics, G_c . With the switch on the temperature of the serpentine (t_s , typically around $16^\circ C$) is given as input to the process. With the switch off the room temperature will move towards a value between t_e and t_v , see the switch in Fig. 4. The approach is to consider lumped transfer functions that model the process with sufficient precision to allow a controller to provide thermal comfort. The distributed heat flow through the walls is simplified as a 1st order process. The room temperature is modeled by an integrator, Intg, in Fig. 6. The constant K is inversely proportional to the room volume. The gains K_e , K_v , and K_c characterize the thermal boundary between t_o and the respective domain. The heat

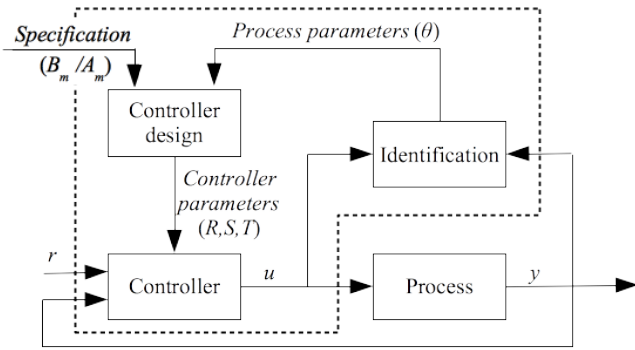

Fig. 7. Block diagram of a self-tuning regulator, Aström and Wittenmark (1995).

flows q_c , q_v , q_e , and q_d can be positive or negative, rising or reducing the room temperature. The first-principle for heat conduction or convection between region x and y is that the flow is given by $q_x = K_x(t_x - t_y)$. In Fig.6 we can recognize that the flows q_c , q_v , and q_e depend explicitly on temperature differences. The access to internal heat flows is a bonus of the first-principle modeling, making clear where the energy is being wasted more. For the linear part in Fig. 6 we apply Mason's rule to obtain the following equation, (1), relating the room temperature (t_o) to the other considered temperatures of the model. (The q_d signal will not be considered for the nominal model).

$$t_o(s) = \frac{\frac{K_e}{T_e s + 1} \frac{K}{s} t_e(s) + \frac{K_v}{T_v s + 1} \frac{K}{s} t_v(s) + \frac{K_c}{T_c s + 1} \frac{K}{s} t_c(s)}{1 + \frac{K_e K}{s} + \frac{K_v K}{s} + \frac{K_c K}{s}}. \quad (1)$$

If we consider only $t_o(s)/t_c(s)$, we have 2^{nd} order model. One pole comes from the straightforward path (which includes the thermal room capacitance, Intg). The second pole comes from the combined gains of the neighborhood and the external environment. More sophisticated models could be used but the 2^{nd} order has proven to be sufficient.

3. ADAPTIVE CONTROL

Some adaptive control techniques applicable for thermal processes have been proposed, see, e.g., Aström and Wittenmark (1995). Among them:

- MRAC - Model Reference Adaptive Control
- RST Self-Tuning Regulator
- Gain Scheduling

Gain scheduling is normally not sufficient. The self-tuning regulator, used here, is in some aspects simpler to design than the MRAC controller. In essence, with RST, we are dealing with well-known pole placement design. One way to implement an adaptive controller is making the process follow a reference model, see Fig. 7. We have two main loops: one composed by the controller and the process, and the second composed by the controller and the parameter adaptation. The parameter change is based on the error feedback between the output of the system and the output of the reference model, Aström and Wittenmark (1995).

3.1 Recursive identification

A recursive estimation algorithm can parallelize data acquisition and processing while taking into account the

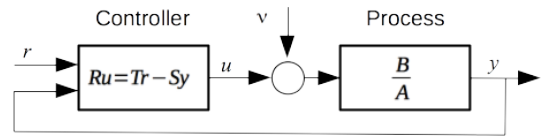

Fig. 8. Two degrees of freedom linear controller used in the pole placement design of the self-tuning controller.

changing nature of the thermal process. Here we will use a recursive version of the least squares identification procedure. The forgetting factor λ gives older samples smaller weights (w_i) than newer ones. It is a tuning parameter that affects stability and plasticity of the adaptation. The weights are given by

$$\begin{cases} w_i(k) = 1, & i = k, \\ w_i(k) = \lambda w_i(k-1), & i < k. \end{cases} \quad (2)$$

The prediction model is $y(k) = \psi_k^T(k-1)\theta_k + \xi(k)$, where $\xi(k)$ is the given modelling error. Considering a minimum variance solution without bias, the Least Squares Estimator with forgetting factor, following the development in Aguirre (2007), is given by

$$\begin{cases} K_k = \frac{P_{k-1}\psi_k}{\psi_k^T P_{k-1}\psi_k + \lambda}, \\ \theta_k = \theta_{k-1} + K_k [y(k) - \psi_k^T \theta_{k-1}], \\ P_k = \frac{1}{\lambda} \left(P_{k-1} - \frac{P_{k-1}\psi_k\psi_k^T P_{k-1}}{\psi_k^T P_{k-1}\psi_k + \lambda} \right), \end{cases} \quad (3)$$

where

ψ_k is the regressor vector with information until $(k-1)$; K_k is the adaptation gain, also referred as Kalman gain; P_k is the covariance matrix of the process, and θ_k is the estimated parameter vector.

3.2 Adaptive control

In this work the RST pole assignment technique was used, Aström and Wittenmark (1995), as depicted in Fig. 8. We will consider a SISO model of the process with input noise

$$A(k)y(k) = B(u(k) + \nu(k)). \quad (4)$$

A generic pole assignment controller can be written as

$$Ru(k) = Tr(k) - Sy(k), \quad (5)$$

where R , S and T are polynomials to be designed. This control law represents a negative feedback by the factor S/R and a feedforward by T/R . The closed loop characteristic equation results in

$$\begin{aligned} y(k) &= \frac{BT}{AR + BS}r(k) + \frac{BR}{AR + BS}\nu(k), \\ u(k) &= \frac{AT}{AR + BS}r(k) + \frac{BS}{AR + BS}\nu(k). \end{aligned}$$

The closed loop characteristic equation is thus

$$A_c = AR + BS. \quad (6)$$

Where A_c is the desired closed loop characteristic equation. Equation (6) is a so called diophantine equation, i.e., we always have a solution if the polynomials A and B have

no common factors. However, we got here only R and S . To obtain T , additional information needs to be calculated. Choosing a reference model to follow $A_m y_m(k) = B_m r(k)$ we have

$$\frac{BT}{AR + BS} = \frac{BT}{A_c} = \frac{B_m}{A_m}. \quad (7)$$

This leads to the possibility that BT and A_c have common factors that can be cancelled. Factoring B as $B^+ B^-$, where B^+ is monic, stable, and well conditioned so that it can be cancelled in the controller. On the other hand, B^- cannot be cancelled and is part of B_m , hence

$$B_m = B^- B'_m. \quad (8)$$

As B^+ is cancelled, it must be a factor of A_c . So, from equation (7), A_m is also a factor of A_c . The closed loop characteristic polynomial has the form

$$A_c = A_0 A_m B^+. \quad (9)$$

The polynomial R can also be factored, leading to

$$R = R' B^+ \quad (10)$$

leading to a reduced diophantine equation

$$AR' + B^- S = A_0 A_m = A'_c \quad (11)$$

and we obtain $T = A_0 B'_m$. The polynomials R, S , and T are calculated in real-time using the identified parameters A and B of the system and, then, equation (5) gives the actual adaptive control signal $u(k)$.

4. RESULTS

Two conventional controllers will be compared to the adaptive controller: an On-Off and a PI controller. The On-Off controller uses as design parameter only the switching hysteresis; in our experiments we used of 1°C. The PI controller uses the error ($E(s) = R(s) - Y(s)$) as input. The parameters were here tuned using the Chien-Hrones-Reswick method, as described in Xue et al. (2009), leading to

$$D_{PI}(z) = \frac{U(z)}{E(z)} = \frac{-0.41424(z - 0.9975)}{z - 1}. \quad (12)$$

Considering that thermal processes are slow, the data for the model identification was acquired over 3 days. Sampling rate was 1 sec (not necessary for the thermal process, but convenient for the analysis). The identification was carried out using MatLab[®] ident toolbox. The identification of the thermal process using a proper PRBS (Pseudo Random Binary Signal) input gave the following discrete transfer function (with 91% fitting):

$$\frac{Y(z)}{U(z)} = \frac{-0.0219z + 0.0154}{z^2 - 1.918z + 0.9191} z^{-3}. \quad (13)$$

The structure of this transfer function will be used to identify A and B polynomials used in the adaptive controller. The corresponding regressor is thus

$$\psi^T(k) = [y(k-1) \ y(k-2) \ u(k-5) \ u(k-4)], \quad (14)$$

with the parameter vector given by $\theta(k) = [\theta_1 \ \theta_2 \ \theta_3 \ \theta_4]^T$. A typical estimation of the parameters can be seen in Fig. 9.b. A 2nd order low pass Butterworth filter, with 1Hz cut

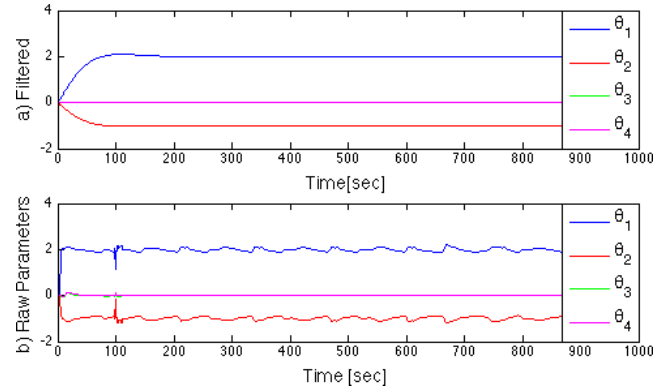

Fig. 9. Estimated model parameters: a) smooth filtered parameters, b) raw estimated model parameters.

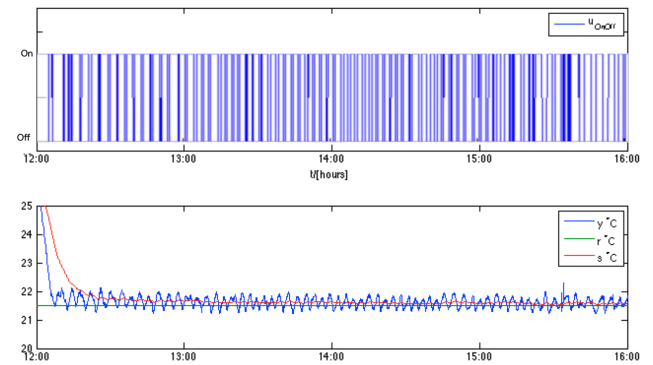

Fig. 10. Typical results for On-Off controller, variable thermal load.

frequency, was used to smooth the measured signals and to reduce noise, Fig. 9.a The parameters were estimated using a recursive algorithm with forgetting factor, Equation 3. To smooth the adaptive signals used, in spite of the PWM switching, a weighted moving average version of the measured temperature was used (s in Figs. 10, 11 and 12),

$$s_k = a^3 y_{k-3} + a^2(1-a)y_{k-2} + a(1-a)y_{k-1} + (1-a)y_k, \quad (15)$$

where $a = 0.995$ is a weighting factor. The reference model for the RST self-tuning controller to follow was chosen to be approx. 5 times faster than the identified open loop dynamics, Eq. 13, as

$$\begin{cases} Am = q^2 - 1.0099q + 0.08738, \\ Bm = 0.0925q. \end{cases} \quad (16)$$

People entering and leaving the meeting room caused a considerable disturbance with great loss of cooled air. Due to the noise nature of the thermal system, the use of a low pass filter simplified the design of the adaptive controller, see Eq. 15. It makes no sense, for thermal comfort (considering the predicted 5% of dissatisfied, Fanger (1973), to reject the small fluctuations of the temperature caused by switching the compressor on and off. The temperatures obtained by the implemented On-Off and PI controllers can be seen in Fig. 11 and 12. Experiments run 8 hours, in figure, 4 hours are shown to enhance the transitions. More figures are not included due to space limitations.

Table 1 compares the three different controllers used for the meeting room. Two conditions were investigated:

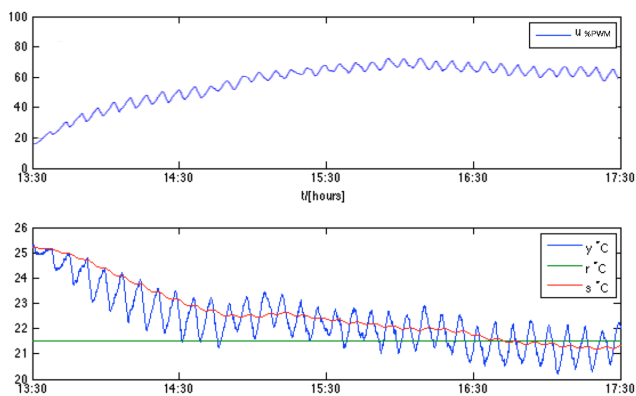

Fig. 11. Typical results for PI control. Experiment with variable thermal load.

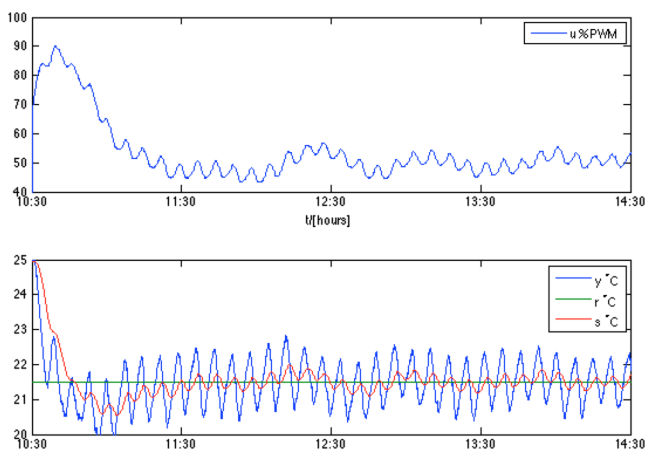

Fig. 12. Actuator and temperatures signal in meeting room with RST controller, variable thermal load.

Table 1. Controllers RMS error and energy (En.) [KWh], under different thermal loads.

Thermal Load	On-Off		PI		Adaptive	
	Error	En.	Error	En.	Error	En.
Constant	0.14	6.69	1.55	3.12	0.53	3.42
Variable	0.12	7.89	1.18	4.85	0.43	4.63

constant thermal load, where the empty meeting room's door was kept closed and variable thermal Load, were occupancy changed with typical meetings, studying, and vacancy periods. Opening the door always favored large heat flow (the process parameters change). The On-Off controller always needs more energy. With constant thermal load the PI could maintain comfort with slightly less energy. Considering variable thermal load, the PWM actuated PI controller could spare 42.6% energy, compared to the conventional On-Off controller. The more sophisticated RST adaptive controller reached up to 45.2% saving.

5. CONCLUSION

The objective of this work was to investigate the adaptive control of a PWM actuated air conditioning system considering energy saving and thermal comfort. The starting point for a self-tuning adaptive controller was to obtain a recursive identification of the system, taking into account the time-varying nature of buildings. The recursive least squares identification of the meeting room with a 2nd

order first-principles based model reached mean quadratic error of the order of 0.015. The adaptive controller was compared with an On-Off and a PI controller. The PI and the adaptive controller were used with a PWM actuation scheme that considered the low-pass characteristic of the process. The comparison shows that the On-Off controller consumes the most energy. The PI has a better following of the set point (thermal comfort), but is slow to reach the set point. The adaptive controller seems to be the best solution for model based building climatization: lowest energy consumption with good thermal comfort. The hardware and software necessary are more expensive, but the quick pay back by the energy saving makes it worth.

ACKNOWLEDGEMENTS

The authors thank CNPq and FINATEC/UnB for the support.

REFERENCES

- Adolph, M., Kopmann, N., Lupulescu, B., and Müller, D. (2014). Adaptive control strategies for single room heating. *Energy and Buildings*, 771–778.
- Aguirre, L. (2007). *Introducao a Identificacao de Sistemas - Tecnicas Lineares e Nao-Lineares Aplicadas a Sistemas Reais*. Ed. UFMG, Belo Horizonte, 3rd edition.
- Aström, K. and Wittenmark, B. (1995). *Adaptive Control*. Addison-Wesley, 2nd edition.
- Bauchspiess, A., Ishihara, J., Felgner, F., and Litz, L. (2006). First-principles structured identification for predictive hvac control. *CLCA2006*, 42–47.
- Bauchspiess, A., R.N.Such, and Flores, J. (2013). Fuzzy hybrid air-conditioning for thermal comfort and energy efficiency. *COBEM2013*, 8603–8614.
- Fanger, P. (1973). *Thermal Comfort*. McGraw Hill, New York, republished edition.
- Gwerder, M., Tödtli, J., Lehmann, B., Dorer, V., Güntensperger, W., and Renggli, F. (2009). Control of thermally activated building systems (tabs) in intermittent operation with pulse width modulation. *Applied Energy*, 1606–1616.
- Melo, A., Sorgato, M., and Lamberts, R. (2014). Building energy performance assessment: Comparison between ashrae standard 90.1 and brazilian regulation. *Energy and Buildings*, 372–283.
- Nesler, C. (Aug 1986). Adaptive control of thermal processes in buildings. *IEEE Control Syst Mag*, 9–13.
- Nguyen, T. and Aiello, M. (2013). Energy intelligent buildings based on user activity: a survey. *Energy and Buildings*, 244–257.
- Salsbury, T. (2002). A new pulse modulation adaptive controller (pmac) applied to hvac systems. *Control Engineering Practice*, 1357–1370.
- Shaikh, P., Nor, N., Nallagownden, P., Elamvazuthi, I., and Ibrahim, T. (2014). A review on optimized control systems for building energy and comfort management of smart sustainable buildings. *Renewable and Sustainable Energy Reviews*, 409–429.
- Tianyi, Z., Jili, Z., and Dexing, S. (2011). Experimental study on a duty ratio fuzzy control method for fan-coil units. *Buildings and Environment*, 527–534.
- Xue, D., Chen, Y., and Atherton, D. (2009). *Linear Feedback Control: Analysis and Design with MatLab*. SIAM, 1st edition.